

CRYSTORAMA

LIGHTING THE WAY FOR SIXTY YEARS

ASSEMBLY INSTRUCTION MODEL #CLO-8897-AG

WARNING:



Electrical Danger



Turn Power Off

All electrical components must be installed by a licensed electrician in accordance with the National Electric Code and the appropriate local electrical codes.

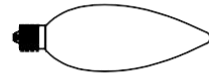

You will need 12-Cand.BULB
60 watts Max Bulb not included
USE LED BULBS FOR EXTENDED USE

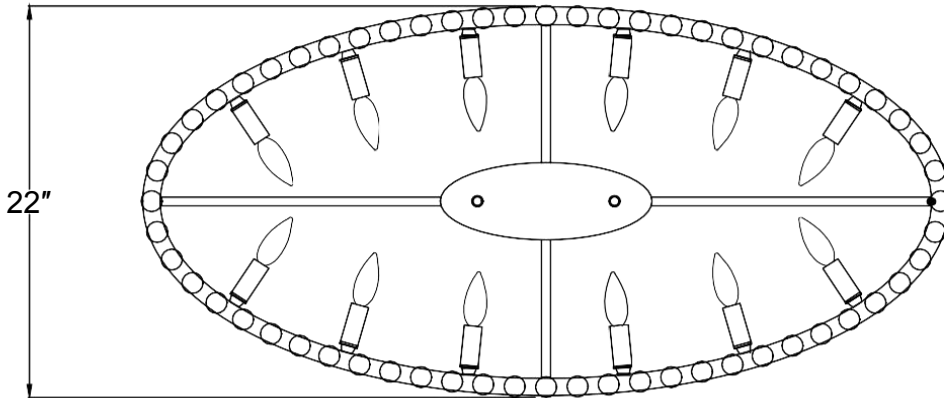

How to Install

1. Attach the Rods onto the nipple on top of fixture. Determine the preferred height and adjust to the required rods.
2. Hook the chain onto the Rods by quicklink. Determine the preferred height and adjust to the required chain.
3. Install the recommended bulb into each socket and install the crystal ball on the bottom ring.
4. Insert each long threaded crystal ball through the bottom of the ring, then secure it from the top with the crystal ball (without nipple).

CRYSTAL SETS:

M: \varnothing 30mmx60, Crystal ball with long thread
 \varnothing 30mmx60, Crystal ball

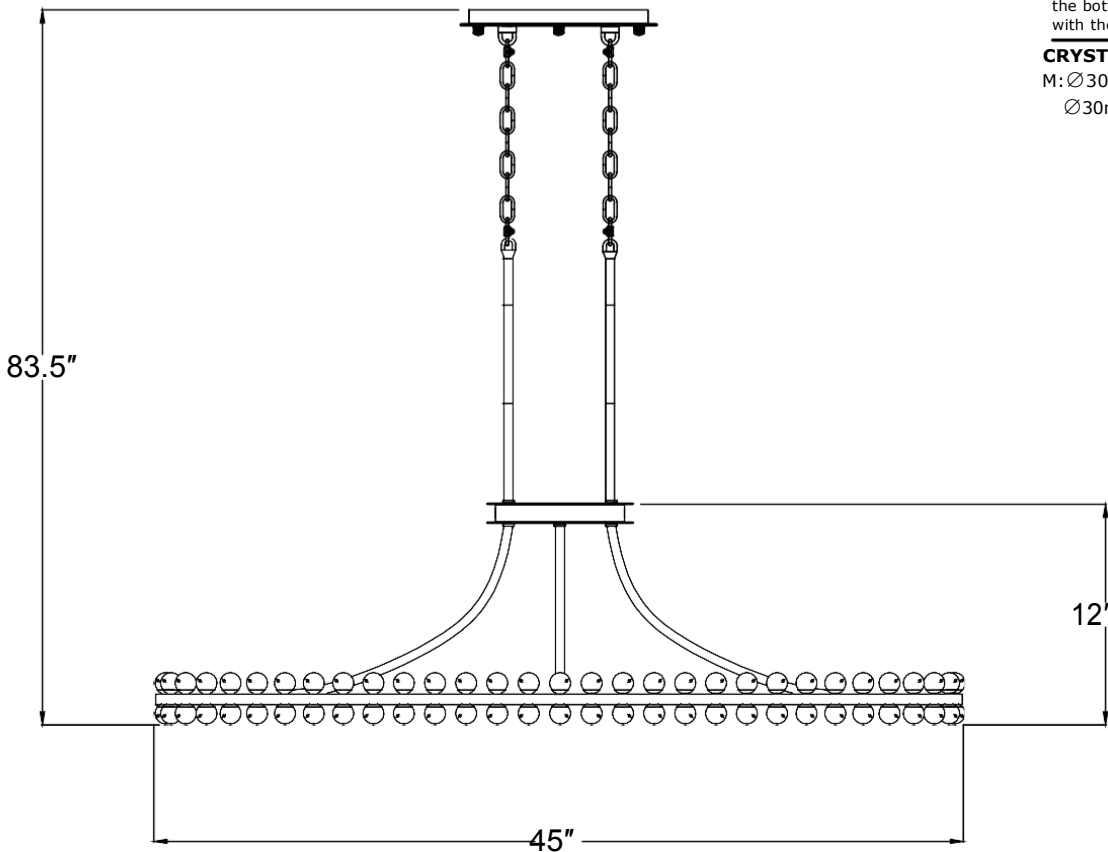

M:



WARNING: This product can expose you to Lead, which is known to the State of California to cause cancer and/or birth defects or reproductive harm. For more information go to www.P65Warnings.ca.gov

CRYSTORAMA

LIGHTING THE WAY FOR SIXTY YEARS

PART NUMBER MODEL #CLO-8897-AG

Part Number

Part Numbers

- A. Mounting Hardware
 - (3) Wire Nut
 - (1) Mounting Plate
 - (2) Mounting Screws
 - (4) Wall anchor
 - (4) Anchor Screw
- B. (1) Oval canopy; 10"x5"x1"h
XMO8897AGCAN10IN
- C. (1) Screw Collar Loop
- D. (4) Ball Nut; XMO8897AGBANUT
- E. (2) Chain; 36"L x Ø5.0mmT;
XMO8897AGCHA5.0MM
- F. (4) Quick Link
- G. (1) Loop
- H. (2) Rod; Ø0.5"x6"h; XMO8897AGROD6IN
- I. (4) Rod; Ø0.5"x12"h; XMO8897AGROD12IN
- J. (1) Wiring Box
- K. (4) Arm; Ø0.5"
- L. (1) Bottom Ring
- M. (120) Crystal ball
- N. (12) Candle Sleeve; Ø1"x2.4"h
XMO8897AGCDL2.4IN

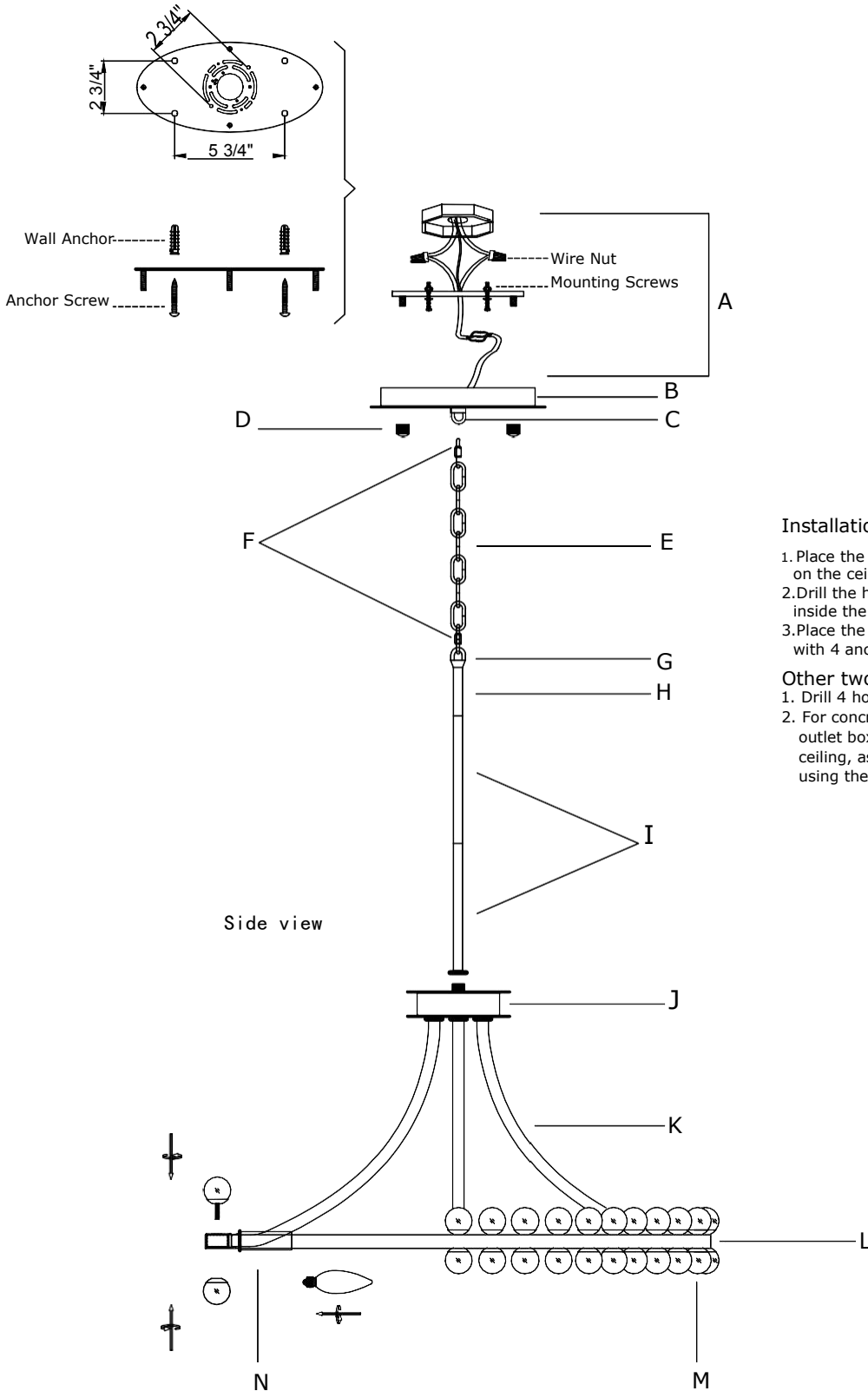





Installation of mounting plate

1. Place the mounting plate over the outlet box and mark 4 Points on the ceiling at the center of the 4 holes on the mounting plate.
2. Drill the holes at the 4 marked points. Insert the wall anchors inside the holes.
3. Place the mounting plate over the outlet box and secure it with 4 anchor screws.

Other two options for Mounting Plate installation:

1. Drill 4 holes in the wall aligning the 4 holes on Mounting Plate.
2. For concrete ceiling, assemble the Mounting Plate to the wall outlet box by using the enclosed 4 Set Screws. For wooden ceiling, assemble the Mounting Plate to the wall outlet box by using the enclosed 4 Anchor Screws.

			
x4	x4	x2	x3
Wall Anchor	Anchor Screw	Mounting Screw	Wire Nut