

CRYSTORAMA

LIGHTING THE WAY FOR SIXTY YEARS

ASSEMBLY INSTRUCTION MODEL#RAM-A3403-VG



All electrical components must be installed by a licensed electrician in accordance with the National Electric Code and the appropriate local electrical codes.



You will need 3- Medium Base Bulb
40 Watts Recommended 60 Watts Max.
USE LED BULBS FOR EXTENDED USE

FRONT VIEW

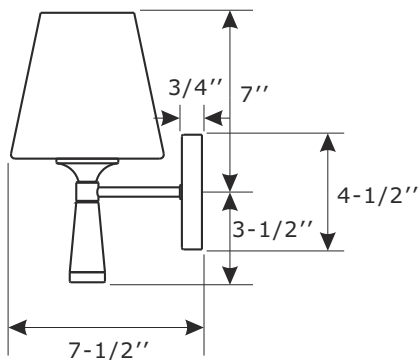
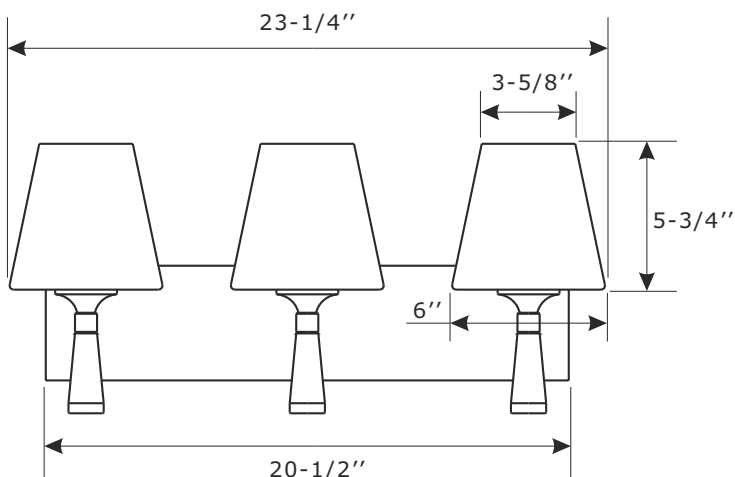

SIDE VIEW

How to install

1. Place the mounting plate over the outlet box. Mark two points on the wall at the center of keyhole on the mounting plate.
2. Drill two holes at the marked points and insert the wall anchors.
3. Place the mounting plate over the outlet box and secure it with outlet box screws. Insert the anchor screws inside the wall anchor inside the wall and tighten it.
4. Install backplate onto the mounting plate, and secure with the screws.
5. Thread the nipple into the bottom of socket. Slide the crystal over the nipple, then secure it with the finial.
6. Place the glass shade over the socket, and secure with the socket ring.
7. Install the bulb(not included) into socket.

CRYSTORAMA

LIGHTING THE WAY FOR SIXTY YEARS

ASSEMBLY INSTRUCTION MODEL#RAM-A3403-VG

Part Number

Part Numbers

- A. (1)-Mounting hardware
- B. (1)-Mounting plate
- C. (1)-Backplate L20-1/2"xW4-1/2"xD3/4" #XRF3403VGBKP20.5IN
- D. (4)-Screw
- E. (3)-Finial #XRF3401VGFIN
- F. (3)-Crystal #XRF3401BOTCRY
- G. (3)-Nipple
- H. (3)-Socket
- I. (3)-Glass shade #XRF3401SHA6IN
- J. (3)-Socket ring

