

CRYSTORAMA

LIGHTING THE WAY FOR SIXTY YEARS

ASSEMBLY INSTRUCTION MODEL #8861-AG

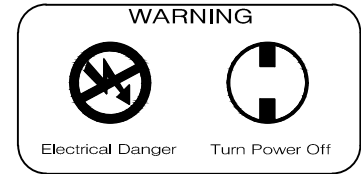
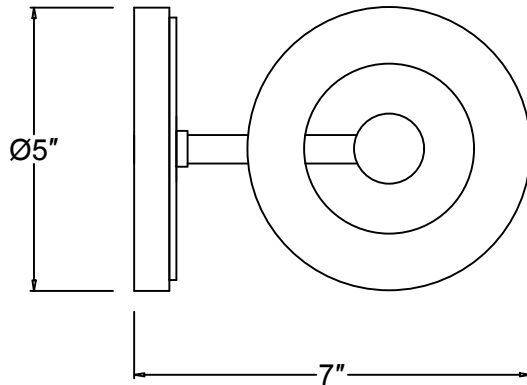

All electrical components must be installed by a licensed electrician in accordance with the National Electric Code and the appropriate local electrical codes.

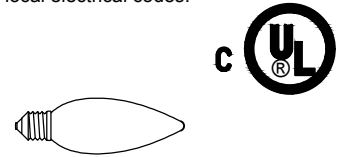

You will need 1-Candelabra Bulb
40 Watts Recommended 60 Watts Max
Bulb not included
USE LED BULBS FOR EXTENDED USE
This fixture is DRY rated

How to Install

1. Attach the Back Plate onto the mounting plate.
2. Install the shade onto the socket.
3. Screw the finial onto the frame.

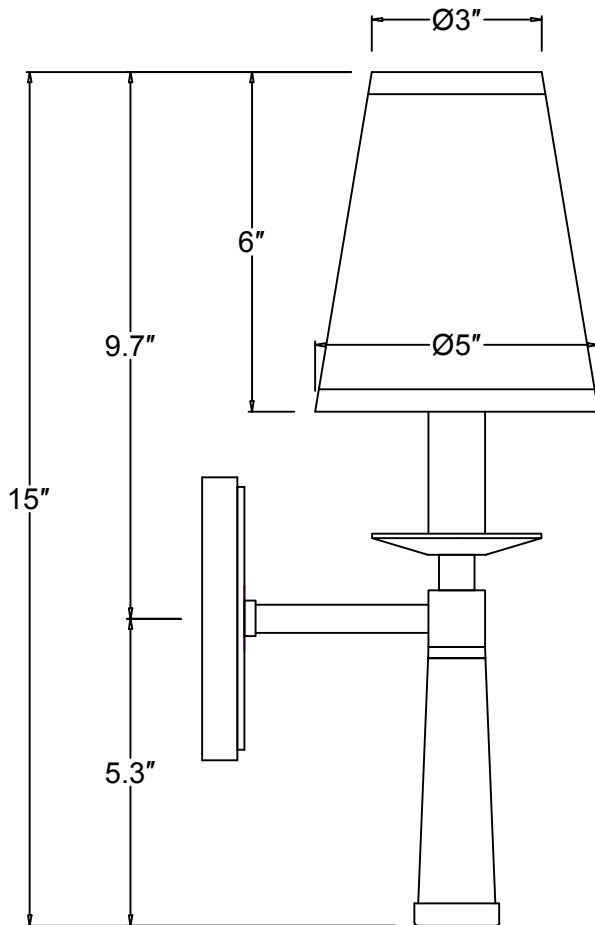

WARNING: This product can expose you to Lead, which is known to the State of California to cause cancer and/or birth defects or reproductive harm. For more information go to www.P65Warnings.ca.gov

CRYSTORAMA

LIGHTING THE WAY FOR SIXTY YEARS

PART NUMBER MODEL #8861-AG

Part Number

Part Numbers

A. Mounting Hardware

(1) Mounting Plate

(2) Wire Nut

(3) Screws

B. (1) Back plate; $\varnothing 5" \times 0.6" \text{h}$; XMO8861AGBKP0.6IN

C. (1) Lucite finial; XMO8861AGLUCFIN

D. (1) Socket

E. (1) Shade; $\varnothing 3" \times \varnothing 5" \times 6" \text{h}$; XMO8861AGSHA6IN

